

WÖHWA

belt feeder

connection of belt feeders with frequency inverter and MPM100 module on Wöhwa control systems

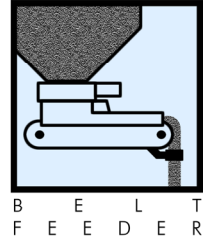

Before starting work, disconnect the main load switch and observe all safety and accident prevention rules. Installation and maintenance work is to be carried out by qualified personnel only. WÖHWA cannot be held responsible for any damages caused by improper installation or maintenance work. All information and safety instructions contained in the frequency inverter manual are to be observed.

sequence of installation work

- Mount the fixture and the corresponding motor protection switch on the bus bar (400 V, 16A. The pre-fuse must match the fuse of the 4kW-frequency inverter FUJI C1-series, not the motor's rated current.
- Mount the contactor, the frequency inverter and MPM100 module on the mounting plate. If possible, connect the shielded motore cable (4 x 2.5 mm²) directly at the frequency inverter (without using a terminal strip).
- Use the correct cable size to wire the main power circuit 400 V (minimum size of 2.5 mm²). 24 V DC is used for the control circuit.
- Single conductors are used to control the MPM100 module.

The minimum wire sizes for the cable types listed in this document are minimum recommendations. Those responsible for installing the cables on site must check what sizes, cable types and lengths and type of conduits are required to meet the conditions prevailing on site.

Only shielded wires must be used for the control circuits. The shielding layer of the shielded wires must be grounded. Route the wiring of the control terminals as far from the wiring of the main circuit as possible to avoid malfunctions (recommendation: a minimum of 4 inches). When crossing the control circuit wiring with the main circuit wiring, set them at right angles.

signals from the PLC to the MPM100 module

Increase frequency (terminal 1 +)
Reduce frequency (terminal 2 -)
Power supply 24 V DC (terminal 5: + 24 V DC, terminal 6: ground 24 V)

CAUTION!! In order to stop the belt feeder when emergency-off is activated, the power supply must be cut after emergency-off has been activated!

Reset (terminal 3 Reset) (Functions only as impulse, not as permanent signal)
Run signal for PLC and manual operation (terminal 8 Run)



WÖHWA belt feeder

connection of belt feeders with frequency inverter
and MPM100 module on Wöhwa control systems

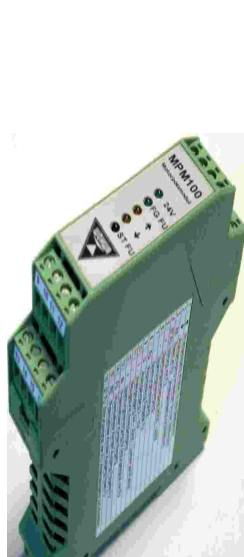
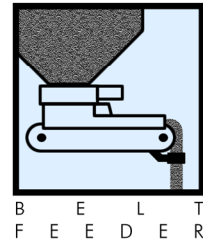

MPM100



connections for
PLC/Power Circuit



connections for
frequency inverter

Shielded wires must be used for the connections between frequency inverter and MPM100 module (LiYCY 8 x 0.34).

connections frequency inverter FUJI C1 – MPM100 module

terminal frequency inverter	terminal MPM100 module
30C	12 / 24 V DC
30 A / alarm	16 / alarm frequency inverter
11 / 0 V	11 / - analog nominal value
12 / voltage input	9 / external analog input voltage
X3 / reset	15 / reset
FWD / forward operation command	14 / FWD
PLC / 24 V	13 / 24 V DC

Before using the frequency inverter a first time, the function code data must be set.

Programming the frequency inverter and function code data setting

Only specially trained personnel must be allowed to do the programming of the frequency inverter to avoid damaging the inverter or belt feeder. Wrong programming may cause malfunctions and/or short circuits and/or defects and/or extensive material damage.



WÖHWA belt feeder

connection of belt feeders with frequency inverter
and MPM100 module on Wöhwa control systems

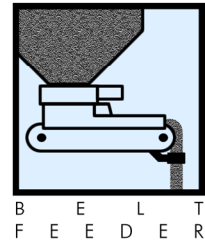

LED monitor of the frequency inverter

Pressing the PRG key switches the inverter to the programming mode. The arrow keys are used to select the functions and change the function data on the LED monitor. Once the function you want to change is displayed, press the function key and use the arrow keys to select the data. Afterwards, press the function key again to store the selected data.

Functions will be displayed in the order F,E,C,P,H,J,Y.
Pressing the PRG key again switches the inverter to Running Mode.

function codes and data to be set

function code	setting	function	default setting
F01	1	0-10V frequency command	
F02	1	operational mode	
F03	100Hz	maximum frequency	
F04	50Hz	base frequency	X
F07	0,1sec	acceleration time	
F08	0,1sec	deceleration time	
F15	100Hz	frequency limiter (peak)	
F16	5Hz	frequency limiter (bottom)	
E03	8	alarm reset	X
E27	99	alarm relay output	X
H06	1	cooling fan off	

connections at the frequency inverter with WÖHWA control systems

Connect the main circuit power input terminal / inverter output terminals first and then the control circuit terminals.



WÖHWA belt feeder

connection of belt feeders with frequency inverter
and MPM100 module on Wöhwa control systems

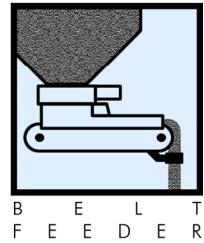

control circuit terminal block cover

Connect the control circuit terminals after removing the cover (pull cover towards you).

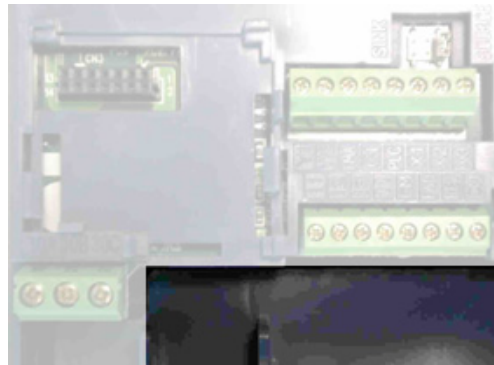

main circuit terminal block cover

The Control Circuit Terminal Block Cover has to be taken off first before the Main Circuit Terminal Block Cover can be removed. Hold both sides of the cover between thumb and forefinger and slide it towards you. The terminals are now accessible for connections to be made(see picture).



connections



connection of main circuit power input terminals
(from contactor with protection switch)



inverter output terminals



WÖHWA belt feeder

connection of belt feeders with frequency inverter
and MPM100 module on Wöhwa control systems

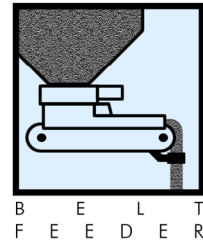

connections at the frequency inverter without a WÖHWA control system

Before starting work, disconnect the main load switch and observe all safety and accident prevention rules. Installation and maintenance work is to be carried out by qualified personnel only. WÖHWA cannot be held responsible for any damages caused by improper installation or maintenance work. All information and safety instructions contained in the frequency inverter manual are to be observed.

sequence of installation work

- Mount the fixture and the corresponding motor protection switch on the bus bar (400 V, 16A). The pre-fuse must match the fuse of the 4kW-frequency inverter FUJI C1-series, not the motor's rated current.
- Mount the contactor, the frequency inverter and MPM100 module on the mounting plate. If possible, connect the shielded motore cable (4 x 2.5 mm²) directly at the frequency inverter (without using a terminal strip).
- Use the correct cable size to wire the main power circuit 400 V (minimum size of 2.5 mm²). 24 V DC is used for the control circuit.
- Single conductors are used to control the MPM100 module.
- Only shielded wires are to be used for the control circuit. The following signals are required. Power supply, Forward Operation Command, RUN signal, alarm, reset and input voltage. The frequency inverter's own voltage is used.

connection diagram control circuit

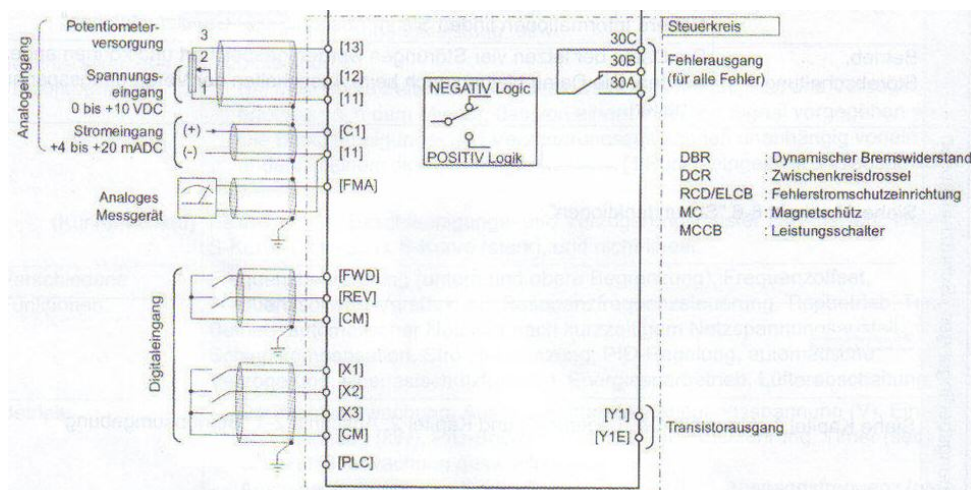

Source: Fuji Manual

CAUTION! Maximum contact rating at alarm output 60 V DC!



WÖHWA

belt feeder

connection of belt feeders with frequency inverter and MPM100 module on Wöhwa control systems

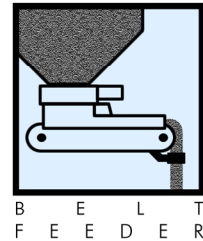

terminal frequency inverter FUJI C1	function
30C	24 V DC alarm relay output
30A / alarm	alarm frequency inverter
11 / 0V	input voltage -
12 / voltage input	external analog input voltage +
C1 / current input	external analog input current +
X3 / reset	reset frequency inverter
FWD / forward operation command	forward operation command
CM	voltage frequency inverter

The minimum wire sizes for the cable types listed in this document are minimum recommendations. Those responsible for installing the cables on site must check what sizes, cable types and lengths and type of conduits are required to meet the conditions prevailing on site.

Only shielded wires must be used for the control circuits. The shielding layer of the shielded wires must be grounded. Route the wiring of the control terminals as far from the wiring of the main circuit as possible to avoid malfunctions (recommendation: a minimum of 4 inches). When crossing the control circuit wiring with the main circuit wiring, set them at right angles.

